

Storage Stand Up 8 and 11 Bike Cut Sheet

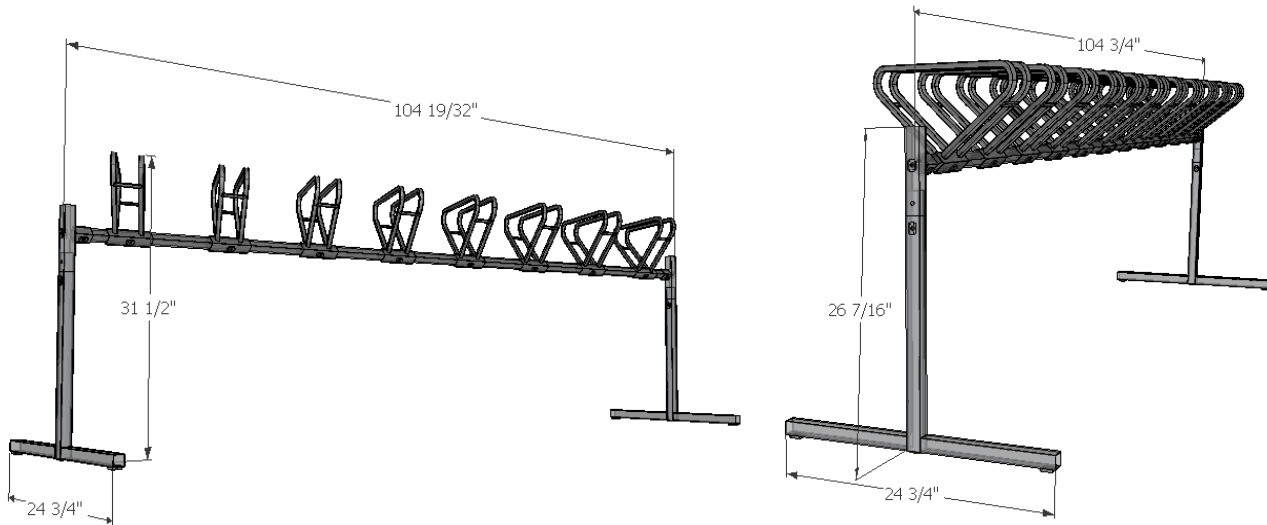

Single Sided



Double Sided

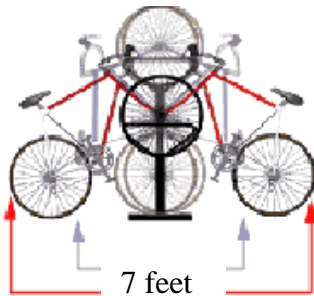

Specifications:

- Holds 8 total bikes in single sided format
- Holds 11 total bikes in double sided format
- Allow for a minimum 3' aisle in front of rack
- Allow for 6" on either end of rack for handlebars
- Rails, end posts and t-bases are 1¼ square 14 Gauge Steel
- All pieces are powder coated with a flat black finish for durability.
- Hand welded in Wisconsin.
- Welds are guaranteed against breakage